

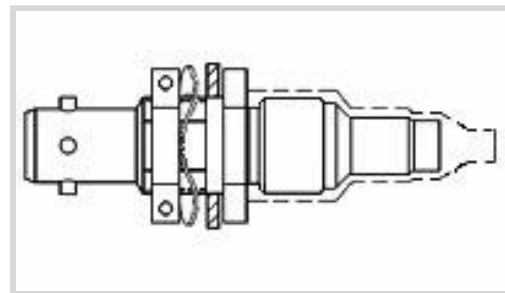

Cable Assemblies > Data Bus Components > Data Bus Connectors



Data Bus Connector Type: **Jack**

Data Bus Connector Style: **Bayonet**

Polarization Code: **A**

Contact Type: **Socket**

Features

Product Type Features

Product Type	Data Bus Component
Data Bus Connector Type	Jack
Data Bus Connector Style	Bayonet

Contact Features

Contact Type	Socket
--------------	--------

Termination Features

Connection Type	Solder
-----------------	--------

Mechanical Attachment

Polarization Code	A
-------------------	---

Usage Conditions

Operating Temperature (Max)	125 °C
-----------------------------	--------

Product Compliance

[For compliance documentation, visit the product page on TE.com>](#)

EU RoHS Directive 2011/65/EU	Not Compliant
EU ELV Directive 2000/53/EC	Not Compliant
China RoHS 2 Directive MIIT Order No 32, 2016	Restricted Materials Above Threshold
EU REACH Regulation (EC) No. 1907/2006	Current ECHA Candidate List: JUNE 2022 (224) Candidate List Declared Against: JUL 2021 (219)

SVHC > Threshold:

Pb (37% in Solder)

Article Safe Usage Statements:

Do not eat, drink or smoke when using this product. Wash thoroughly after handling. Recycle if possible and dispose of the article by following all applicable governmental regulations relevant to your geographic location.

Halogen Content

BFR/CFR/PVC Free, but Br/Cl >900 ppm in other sources.

Solder Process Capability

Not applicable for solder process capability

Product Compliance Disclaimer

This information is provided based on reasonable inquiry of our suppliers and represents our current actual knowledge based on the information they provided. This information is subject to change. The part numbers that TE has identified as EU RoHS compliant have a maximum concentration of 0.1% by weight in homogenous materials for lead, hexavalent chromium, mercury, PBB, PBDE, DBP, BBP, DEHP, DIBP, and 0.01% for cadmium, or qualify for an exemption to these limits as defined in the Annexes of Directive 2011/65/EU (RoHS2). Finished electrical and electronic equipment products will be CE marked as required by Directive 2011/65/EU. Components may not be CE marked. Additionally, the part numbers that TE has identified as EU ELV compliant have a maximum concentration of 0.1% by weight in homogenous materials for lead, hexavalent chromium, and mercury, and 0.01% for cadmium, or qualify for an exemption to these limits as defined in the Annexes of Directive 2000/53/EC (ELV). Regarding the REACH Regulation, the information TE provides on SVHC in articles for this part number is based on the latest European Chemicals Agency (ECHA) 'Guidance on requirements for substances in articles' posted at this URL: <https://echa.europa.eu/guidance-documents/guidance-on-reach>

Compatible Parts



TE Part # 750984-004
10612-24-9

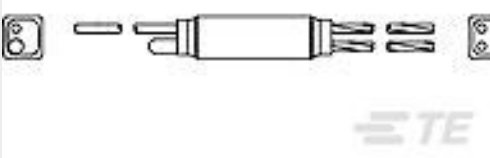

TE Part # CW5133-000
D-500-L458-3-613-240

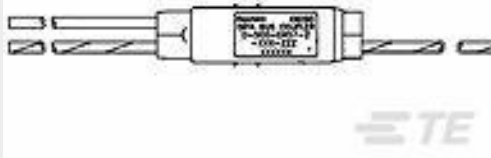

TE Part # 086143-000
D-500-0457-2-613-078



TE Part # 963767-000
D-500-0458-1-613-078

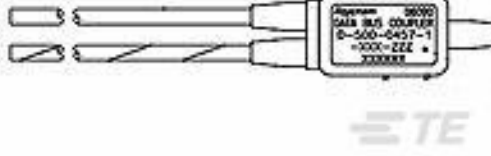

TE Part # 305965-000
D-500-0457-1-613-078

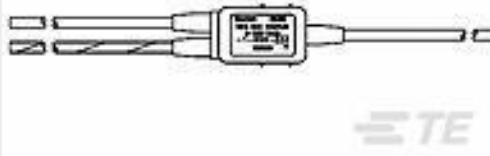

TE Part # 711065-000
D-500-0455-1-613-078

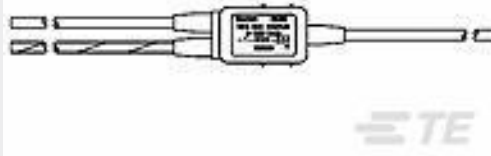

TE Part # 638875-000
D-500-0455-1-612-120



TE Part # CB4500-000
D-500-L458-1-614-120

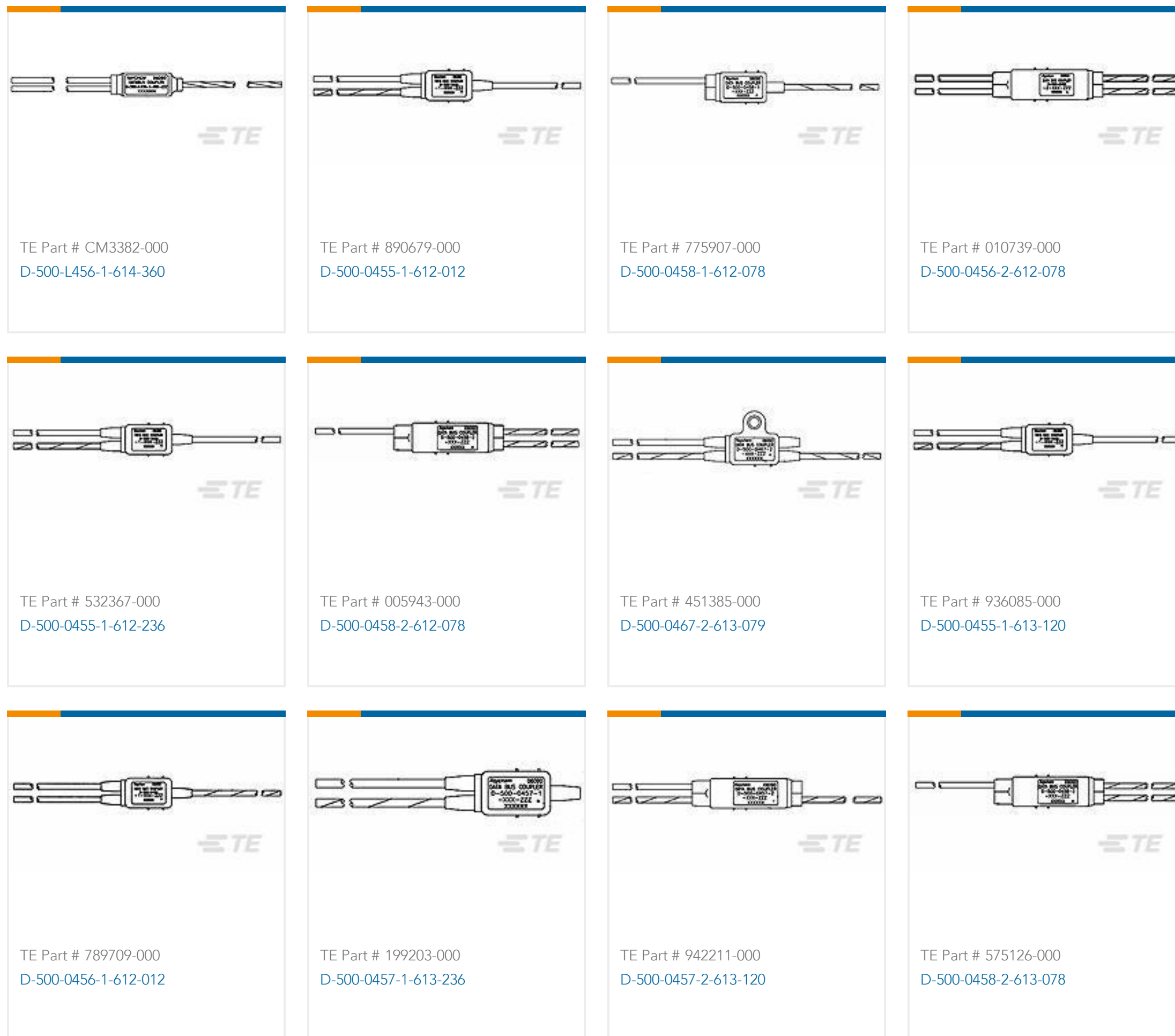

Documents

Product Drawings

[DK-621-0434-1S](#)

English

CAD Files

[3D PDF](#)

3D

Customer View Model

[ENG_CVM_CVM_143981-000_O.2d_dxf.zip](#)

English

Customer View Model

[ENG_CVM_CVM_143981-000_O.3d_igs.zip](#)

English

Customer View Model

[ENG_CVM_CVM_143981-000_O.3d_stp.zip](#)

English

By downloading the CAD file I accept and agree to the [Terms and Conditions](#) of use.

Datasheets & Catalog Pages



Data Bus Components Brochure

English

Product Specifications

Product Specification

English

Instruction Sheets

Instruction Sheet (U.S.)

English